



BRADFORD WHITE[®]
W A T E R H E A T E R S

**Flammable Vapor Ignition Resistant
Water Heaters**

SERVICE MANUAL

Troubleshooting Guide
and Instructions for Service

(To be performed ONLY by
qualified service providers)

DEFENDER
SAFETY SYSTEM[®]

Models Covered by This Manual:

RG130T*(N,X)	RG230S*(N,X)
RG140T*(N,X)	RG230T*(N,X)
RG150T(N,X)	RG240S*(N,X)
RG140S*(N,X)	RG240T*(N,X)
RG150L*(N,X)	RG250H*(N,X)
RG150S*(N,X)	RG250L*(N,X)
LG255H*(N,X)	RG250S*(N,X)
LG275H*(N,X)	RG250T*(N,X)
LG250H65*(N,X)	RG250H*(N,X)
RG2100H*(N,X)	RG255H*(N,X)
	RG275H*(N,X)

(*) Denotes Warranty Years



WARNING
CANCER AND REPRODUCTIVE HARM
WWW.P65WARNINGS.CA.GOV

As required by the state of California Proposition 65.



The Bradford White
DEFENDER
Safety System®

Flammable Vapor Ignition Resistant Water Heaters

Table of Contents

	<u>Page</u>	<u>Service Procedure</u>
Introduction.....	4	---
Troubleshooting Charts.....	6	---
Inner Door Gasket Removal, Inspection, and Replacement.....	12	RG-I
Thermocouple/Thermopile Testing and Replacement.....	15	RG-II
Pilot Assembly Inspection Cleaning and Replacement.....	18	RG-III
Piezo Igniter, Electrode Testing and Replacement.....	19	RG-IV
White Rodgers Mechanical Gas Valve Testing and Replacement.....	20	RG-V
Electronic Gas Control Testing, Disassembly, and Replacement.....	25	RG-VI
Burner Operation Inspection, Adjustment, Cleaning, and Replacement.....	35	RG-VII
Resettable Thermal Switch Testing and Replacement.....	37	RG-VIII
ScreenLok® Flame Arrestor Cleaning.....	39	RG-IX
Diptube and Anode Inspection and Replacement.....	40	RG-X
Parts Diagram.....	42	---
Notes.....	43	---

WARNING: If the information in these instructions is not followed exactly, a fire or explosion may result in property damage, personal injury, or death.

For Your Safety

Do not store or use gasoline or other flammable, combustible, or corrosive vapors and liquids in the vicinity of this or any other appliance.

– WHAT TO DO IF YOU SMELL GAS

- Do not try to light any appliance.
- Do not touch any electrical switch; do not use any phone in your building.
- Immediately call your gas supplier from a neighbor's phone. Follow the gas supplier's instructions.
- If you cannot reach your gas supplier, call the fire department.

– Installation and service must be performed by a qualified installer, service agency, or the gas supplier.

▲ DANGER

DO NOT store or use gasoline or other flammable, combustible, or corrosive vapors and liquids in the vicinity of this or any other appliance.

IMPORTANT

Before proceeding, please inspect the water heater and its components for possible damage. **DO NOT** install any water heater with damaged components. If damage is evident then please contact the supplier where the water heater was purchased or the manufacturer listed on the rating plate for replacement parts.

▲ WARNING

Water heaters are heat producing appliances. To avoid damage or injury, do not store materials against the water heater or vent-air intake system. Use proper care to avoid unnecessary contact (especially by children) with the water heater and vent-air intake components. **UNDER NO CIRCUMSTANCES SHOULD FLAMMABLE MATERIALS, SUCH AS GASOLINE OR PAINT THINNER BE USED OR STORED IN THE VICINITY OF THIS WATER HEATER, VENT-AIR INTAKE SYSTEM OR IN ANY LOCATION FROM WHICH FUMES COULD REACH THE WATER HEATER OR VENT-AIR INTAKE SYSTEM.**

▲ WARNING

Hydrogen gas can be produced in an operating water heater that has not had water drawn from the tank for a long period of time (generally two weeks or more). **HYDROGEN GAS IS EXTREMELY FLAMMABLE.** To prevent the possibility of injury under these conditions, we recommend the hot water faucet to be open for several minutes at the kitchen sink before you use any electrical appliance which is connected to the hot water system. If hydrogen is present, there will be an unusual sound such as air escaping through the pipes as hot water begins to flow. **DO NOT** smoke or have open flame near the faucet at the time it is open.

▲ WARNING

DO NOT ATTEMPT TO LIGHT ANY GAS APPLIANCE IF YOU ARE NOT CERTAIN OF THE FOLLOWING:

- Liquefied petroleum gases/propane gas and natural gas have an odorant added by the gas supplier that aids in the detection of the gas.
- Most people recognize this odor as a "sulfur" or "rotten egg" smell.
- Other conditions, such as "odorant fade" can cause the odorant to diminish in intensity, or "fade", and not be as readily detectable.
- If you have a diminished sense of smell or are in any way unsure of the presence of gas, immediately contact your gas supplier from a neighbor's telephone.

Gas detectors are available. Contact your gas supplier, or plumbing professional, for more information.

▲ WARNING

FAILURE TO INSTALL AND MAINTAIN A NEW, LISTED 3/4" X 3/4" TEMPERATURE AND PRESSURE RELIEF VALVE WILL RELEASE THE MANUFACTURER FROM ANY CLAIM THAT MIGHT RESULT FROM EXCESSIVE TEMPERATURE AND PRESSURES.

▲ CAUTION

If sweat fittings are to be used **DO NOT** apply heat to the nipples on top of the water heater. Sweat the tubing to the adapter before fitting the adapter to the water connections. It is imperative that heat is not applied to the nipples containing a plastic liner.

INTRODUCTION

The Bradford White DEFENDER Safety System®

The Bradford White DEFENDER Safety System® was designed to resist the ignition of flammable vapors that can occur outside of the water heater. Use and installation are nearly identical to previous versions of atmospherically fired and vented water heaters. A number of exclusive design features are incorporated in the system that will require additional knowledge on the part of the qualified service provider. The following information will instruct service professionals on the function, proper diagnosis and repair of water heaters employing the Bradford White DEFENDER Safety System.

How the Safety System Works

During normal operation, air for combustion is drawn into the water heater through the opening in the jacket. This air travels down and around the combustion chamber and enters through holes in the very bottom of the corrosion-resistant combustion chamber. The air then travels up through the oriented flame arrestor plate louvers, where the velocity of the air is increased, and its direction altered. The air then mixes in a normal manner with the supplied gas and is efficiently combusted, producing very low NOx emissions.

In the case where trace amounts of flammable vapors are present in the air flowing into the combustion chamber, the vapors are harmlessly ignited by the burner/pilot flame. If flammable vapors are in sufficient quantity to prevent normal combustion, the burner/pilot flame is shut down.

Should the flammable vapors continue to the burner, the flame arrestor plate prevents the flames from traveling backwards and igniting vapors outside of the combustion chamber. The calibrated, multipurpose thermal switch recognizes this and shuts down the pilot and main burner. This switch also deactivates the burner and pilot in the unlikely event of restricted airflow caused by severe lint, dust, or oil accumulation on the arrestor plate.

It is intended for this manual to be used by qualified service personnel for the primary purpose of troubleshooting and repair of the Bradford White DV Series water heaters.

The ICON System Gas Control will display status codes in the event of abnormal operation. Status codes are listed in the troubleshooting charts found in this service manual. The troubleshooting charts will also indicate the probable cause for the status code and direct the service professional to a service procedure to properly diagnose the abnormal operation.

In some difficult to diagnose conditions, it may be necessary to isolate the heater from the vent system to determine the problem.

Contact the Bradford White technical support group immediately if diagnosis cannot be made using the methods described in this service manual.

Tools Required for Service

Manometer: A liquid "U" tube type or a digital (magnahelic) type can be used. This device is used to measure gas and/or air pressure and vacuum.

Multi-Meter: A digital type is strongly recommended. This device is used to measure electrical values. The meter you select must have the capability to measure volts AC, volts DC, amps, micro-amps, and ohms.

Electronic Probes: In some cases, standard multi-meter probes will damage or simply not be effective to obtain certain voltage and ohm readings. It will be necessary to have special electronic "pin" type multi-meter probes. These probes are available at most electronic wholesale outlets.

Thermometer: Used to measure water temperature. An accurate thermometer is recommended.

Water Pressure Gage: Used to measure water supply pressure. Also used to determine tank pressure by adapting to the drain valve of the heater.

Various Hand Tools: Pipe wrench, channel locks, open end wrenches (3/8", 7/16", 1/2"), 12" crescent wrench, allen wrench set, screw drivers (common & Phillips), 1/4" nut driver, pliers (common & needle nose), socket set, side cutters, wire cutters, wire strippers, wire crimpers, torpedo level, small shop vacuum, step ladder, flashlight, and 5-gallon pail.

White Rodgers Mechanical Gas Control Troubleshooting Chart

Flammable Vapor Ignition Resistant Water Heaters

Symptom	Probable Cause	Corrective Action	Service Procedure
Pilot will not light	<ol style="list-style-type: none"> 1.No incoming gas or too low gas pressure. 2.Gas control knob set to wrong position. 3.Gas control knob not being fully depressed when attempting to light pilot. 4.Pilot orifice or pilot tube is obstructed or kinked. 5.Pilot electrode not sparking to pilot. 6.Piezo igniter not functioning. 	<ol style="list-style-type: none"> 1.Turn on gas supply and/or check line pressure. 2.Review lighting instruction. Set gas control knob to correct position. 3.Review lighting instruction. Fully depress gas control knob. 4.Clean, repair or replace. 5.Verify correct electrode position. Replace pilot assembly. 6.Replace piezo igniter. 	<ol style="list-style-type: none"> 1. See Service Procedure RG-V 2. See Service Procedure RG-III 3. See Service Procedure RG-III 4. See Service Procedure RG-IV
Pilot will not stay lit when button is released	<ol style="list-style-type: none"> 1.Poor thermocouple connection at combination thermostat/gas valve. 2.Thermocouple not fully engaged in pilot assembly bracket. 3.Pilot flame is not fully enveloping the thermocouple bulb. 4.Weak or defective thermocouple. 5.Open ECO in combination thermostat/gas valve. 6.Defective magnet in combination thermostat/gas valve. 7.Resettable thermal switch has opened. 	<ol style="list-style-type: none"> 1.Check connection at combination thermostat/gas valve. Proper tightness should be finger tight + a 1/4 turn. 2. Inspect thermocouple to ensure that it is fully engaged into pilot bracket. 3. Clean pilot orifice and verify pilot tube is clear; check gas supply and line pressure. 4. Check thermocouple and replace if necessary. 5. Check ECO continuity and replace combination thermostat/gas valve if necessary. 6. Check magnet operation and replace combination thermostat/gas valve if necessary. 7. Determine cause of switch activation. To reset, depress button on resettable thermal switch located on inner door. 	<ol style="list-style-type: none"> 1. See Service Procedure RG-II 2. See Service Procedure RG-V 3. See Service Procedure RG-V
Pilot will light but the main burner will not come on	<ol style="list-style-type: none"> 1.Combination thermostat/gas valve set too low for desired water temperature. 2.Combination thermostat/gas valve temperature is satisfied. 3.Insufficient gas supply or low gas pressure. 4.Combination thermostat/gas valve has wide differential or is out of calibration. 	<ol style="list-style-type: none"> 1.Adjust temperature dial on combination thermostat/gas valve. 2.Check temperature dial setting on combination thermostat/gas valve. 3.Check gas supply and line pressure. 4.Check combination thermostat/gas valve for proper operation, replace if necessary. 	<ol style="list-style-type: none"> 1. See Installation and Operation Manual. 2. See Service Procedure RG-V 3. See Service Procedure RG-V

White Rodgers Mechanical Gas Control Troubleshooting Chart

Flammable Vapor Ignition Resistant Water Heaters

Symptom	Probable Cause	Corrective Action	Service Procedure
Pilot goes out periodically (after heating cycles, once a day, once a week etc.)	<ol style="list-style-type: none"> 1. Insufficient combustion air supply. 2. Incorrect or clogged vent system/vent terminal, or incorrect location. 3. Inconsistent gas supply or gas pressure. 	<ol style="list-style-type: none"> 1. Verify adequate combustion air is available to the unit. Check and clear jacket slot openings of any dirt, dust, restrictions or other obstructions. Inspect flame arrestor plate and clean with stiff bristled brush and compressed air to remove any debris accumulation. 2. Check venting for proper sizing and proper operation. 3. Check gas supply and line pressure. 	<ol style="list-style-type: none"> 1. See Service Procedure RG-VIII 2. See Service Procedure RG-V
Not enough hot water	<ol style="list-style-type: none"> 1. Combination thermostat/gas valve set too low for desired water temperature. 2. Cold inlet water temperature is very cold. 3. High demand periods. 4. Incorrectly sized water heater for application. 5. Combination thermostat/gas valve is out of calibration/not functioning. 6. Out of spec dip tube is diluting hot water with cold water. 	<ol style="list-style-type: none"> 1. Check dial on combination thermostat/gas valve. 2. Extremely cold water going into the heater will decrease the amount of hot water produced. It may be necessary to temper incoming water supply. 3. Adjust high demand usage. 4. Contact plumbing professional. 5. Check combination thermostat/gas valve for proper operation, replace if necessary. 6. Inspect dip tube and replace if necessary. 	<ol style="list-style-type: none"> 1. See Service Procedure RG-V 2. See Service Procedure RG-IX

White Rodgers Electronic Gas Control Troubleshooting Chart

Flammable Vapor Ignition Resistant Water Heaters

Observe green LED indicator on gas control. Status flash codes are displayed with a three second pause before repeating. Check and repair the system as noted in the troubleshooting table below.

GREEN LED INDICATOR

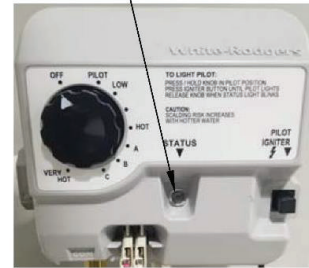

LED Status	Control Status	Probable Cause
None (LED not on or flashing)	Indicates control is off. Main and pilot burner are off.	Gas valve is functioning normally. Gas valve is not powered. Light pilot.
One flash every four seconds	Not an error. Indicates pilot is lit and main burner is off.	Gas valve is powered and waiting for the set point knob to be turned to a water temperature setting. If the set point knob is at desired setting, the thermostat is satisfied.
One flash every second	Not an error. Indicates main valve is open and main burner is lit.	Thermostat is calling for heat. Water heater operating normally and is in heat cycle.
Solid ON	Not an error. Indicates that the control is in shutdown mode.	Set point knob was recently turned to "OFF" position. Wait until LED goes out before attempting to relight.
Two flashes and three second pause	Low thermopile voltage; main burner not lit.	Loose thermopile connections or weak pilot flame.
Four flashes and three second pause	Temperature cut-out limit reached causing shutdown.	Excessive temperatures may have been reached. Shut off the control and reduce the water temperature. Thoroughly verify control operation, replace if exceeding setpoint.
Five flashes and three second pause	Electronics, sensor, or gas valve fault detected.	Control may be wet or damaged. Verify all connections are tight; if problem persists replace the control.

ICON System V1 Gas Control Troubleshooting Chart

Flammable Vapor Ignition Resistant Water Heaters

Observe green LED indicator on gas control. Status flash codes are displayed with a three second pause before repeating. Check and repair the system as noted in the troubleshooting table below.



LED Status	Control Status	Probable Cause	Service Procedure
None (LED not on or flashing)	Pilot assembly is not lit.	Gas control is not powered. Light pilot.	If the pilot will not stay lit replace pilot assembly. If problem persists replace gas control.
One flash and three second pause	<ol style="list-style-type: none"> If setpoint knob is in "PILOT" position then pilot flame is detected. Turn setpoint knob to desired setting. If the setpoint knob is already at the desired setting, the water heater is satisfied. 	<ol style="list-style-type: none"> Gas control is powered and waiting for setpoint knob to be turned to a water temperature setting. Water heater is satisfied and operating normally. 	Normal operation.
LED on continuously (solid)	Setpoint knob has been recently turned to the "OFF" position. Wait until LED goes out before attempting to relight.	Setpoint knob was turned to "OFF" position.	LED will go out and the control will function normally once the pilot is lit.
Two flashes and three second pause	Weak pilot signal detected. System will reset when pilot flame is sufficient.	<ol style="list-style-type: none"> Thermopile failure. Unstable pilot. Pilot tube blocked or restricted. 	<ol style="list-style-type: none"> See Service Procedure IV See Service Procedure II See Service Procedure II
Three flashes and three second pause	Insufficient water heating. System will reset.	<ol style="list-style-type: none"> Thermal sensor out of calibration. Faulty gas control. 	Replace gas control.

ICON System V1 Gas Control Troubleshooting Chart

Flammable Vapor Ignition Resistant Water Heaters

Observe green LED indicator on gas control. Status flash codes are displayed with a three second pause before repeating. Check and repair the system as noted in the troubleshooting table below.



LED Status	Control Status	Probable Cause	Service Procedure
Four flashes and three second pause	Excessive tank temperature. System must be reset.	<ol style="list-style-type: none"> 1. Temperature sensor out of calibration. 2. Faulty gas control. 	Replace gas control.
Five flashes and three second pause	Temperature sensor fault.	<ol style="list-style-type: none"> 1. Damage to the temperature sensor, resistance is out of range, or sensor is unplugged. 2. Faulty gas control. 	<ol style="list-style-type: none"> 1. See Service Procedure VI 2. Replace gas control.
Six flashes and three second pause	Water leak detected by accessory module.	Excessive amount of water in drain pan/water dam.	<ol style="list-style-type: none"> 1. Check T&P valve. 2. Check all water fittings. 3. Pressurize and leak test tank.
Seven flashes and three second pause	Gas control electronic fault detected.	<ol style="list-style-type: none"> 1. Control needs to be reset. 2. Control is wet or physically damaged. 	<ol style="list-style-type: none"> 1. Reset gas control 2. Replace gas control.
Eight flashes and three second pause	Standing pilot remains on while setpoint knob is in "OFF" position.	Pilot valve stuck in open position.	Replace gas control.

ICON System V2 Gas Control Troubleshooting Chart

Flammable Vapor Ignition Resistant Water Heaters

Observe colored LED indicator on gas control. Status flash codes are displayed with a three second pause before repeating. Check and repair the system as noted in the troubleshooting table below.



LED Colors:
Green - Normal operation
Yellow - Low thermopile voltage
Red - Valve fault

LED Status	Control Status	Probable Cause	Service Procedure
None (LED not on or flashing)	Millivolt power is not present. Light pilot.	Gas valve is functioning normally. Gas valve is not powered. Light pilot.	If the pilot will not stay lit replace pilot assembly. If problem persists, replace gas control.
One flash every four seconds (LED green)	Not an error. Indicates pilot is lit and main burner is off.	The knob can be turned to a desired setpoint temperature.	Normal operation.
One flash every second (LED green)	Not an error. Indicates main valve is open and main burner is lit.	None. Control will automatically shut main burner off when water temperature reaches the setpoint temperature.	Normal operation.
Two flashes and three second pause (LED yellow)	Low thermopile voltage; main valve not turned on.	Check thermopile and its connections. Check pilot flame.	1. See Service Procedure IV 2. See Service Procedure II 3. See Service Procedure II
Four flashes and three second pause (LED red)	Temperature cut-out limit reached, causing shutdown.	Check the valves and the water temperature sensor. Reduce the water temperature setpoint. Verify control operation, replace if exceeding setpoint.	Replace gas control.
Five flashes and three second pause (LED red)	Electronics, sensor, or gas valve fault detected.	Check water temperature sensor and its connection for open circuits, shorts, or differences in resistance between the two sensor elements.	Replace gas control.
Solid ON (LED red)	Not an error—indicates that the control is in OFF position.	None; wait until LED turns off if you want to restart system.	LED will go out and the control will function normally once the pilot is lit.

SERVICE PROCEDURE RG-I
Inner Door/Gasket Removal,
Inspection, and Replacement

Inner Door Removal Procedure

Step 1. Rotate knob of the combination thermostat/gas valve to the "OFF" position.

Step 2. Remove the outer jacket burner access door.

Step 3. Inner Door Removal:

- a) Disconnect resettable thermal switch wire leads (leading from gas control/gas valve).
- b) Remove two (2) 1/4" hex drive screws from right side inner door.
- c) Remove two (2) 1/4" hex drive screws from flange section of inner door.
- d) Remove two (2) 1/4" hex drive screws from left side inner door.
- e) Remove inner door and inspect per Step 4.

For "Resideo" & White Rodgers electronic control, rotate knob counter-clockwise to the "OFF" position.



For White Rodgers mechanical control, depress knob slightly and rotate clockwise to the "OFF" position.

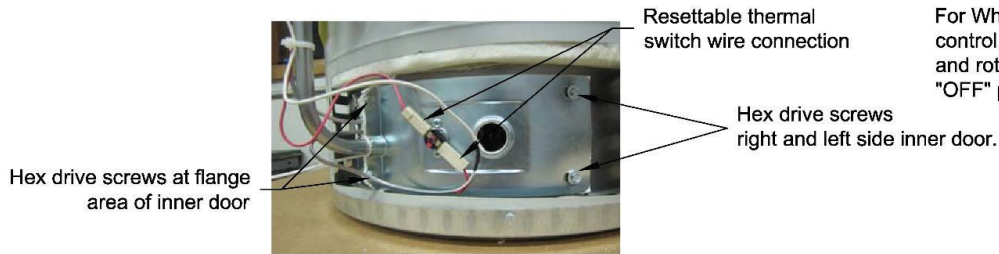

Step 4. Fully inspect inner door gaskets for the following:

- Tears
- Missing material
- Cracks
- Dirt or debris
- Gasket adhesion to inner door
- Material left on combustion chamber (around opening)
- Other imperfections that will inhibit proper seal

If the gasket is not affected by any of the above, gasket replacement is not required. If replacement is required, proceed to **Inner Door Gasket Replacement Procedure**.

Inner Door Gasket Replacement Procedure

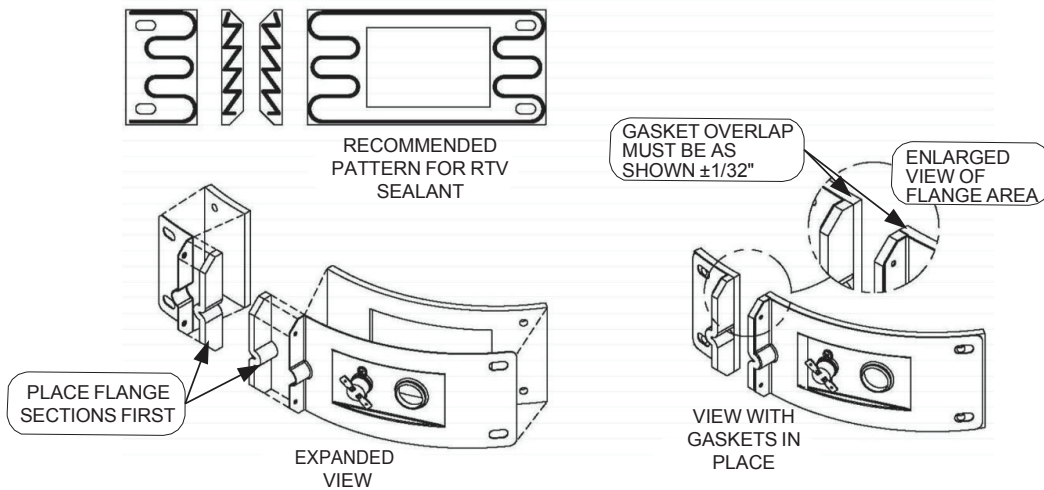

Installation of Inner Door with Gasket

- Step 1. Clean any residual gasket residue or other debris from combustion chamber surface before installing the inner door/gasket assembly.
- Step 2. Place the left side inner door into position first. Firmly position the radiused channel of the inner door around the feedline. Using the two (2) hex drive screws from Step 3d, secure left side inner door in place. **DO NOT OVERTIGHTEN SCREWS.**
- Step 3. Position thermocouple, pilot tube and piezo wire against left side inner door flange gasket. **DO NOT ROUTE THROUGH RADIUSED CHANNEL WITH FEEDLINE.**

⚠ WARNING

Stripped fastener connections may allow for seal breach of inner door. A seal breach may result in a fire or explosion causing property damage, personal injury or death. DO NOT overtighten screws in Steps 2, 4, and 5.

If a fastener connection is stripped, contact the manufacturer listed on the water heater rating plate.



Radiused channel for feedline

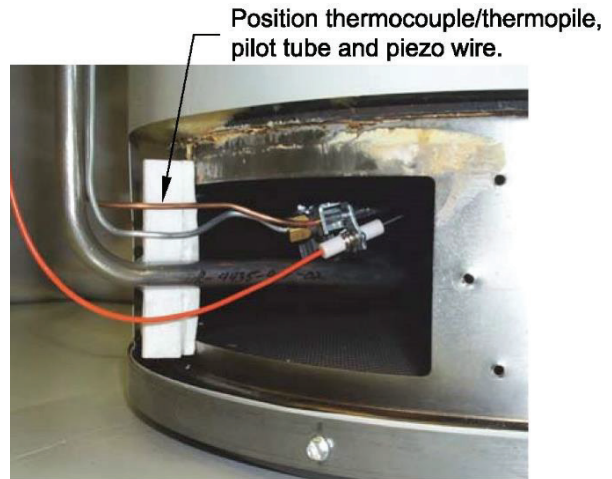

Position thermocouple/thermopile, pilot tube and piezo wire.

SERVICE PROCEDURE RG-I
Inner Door/Gasket Removal, Inspection
Replacement and Reinstallation

- Step 4. Firmly place right side inner door flange against the left side inner door flange and secure with two (2) 1/4" hex drive screws from Step 3c. **DO NOT OVER TIGHTEN SCREWS.**
- Step 5. Align the right side inner door to combustion chamber and verify that the fastener holes of the combustion chamber are aligned with the right side inner door slotted opening. Verify seal integrity around the combustion opening. Secure right side inner door using two (2) 1/4" hex drive screws from Step 3b. **DO NOT OVER TIGHTEN SCREWS.** Verify both left and right sides of the inner door are properly positioned and sealed against the combustion chamber.

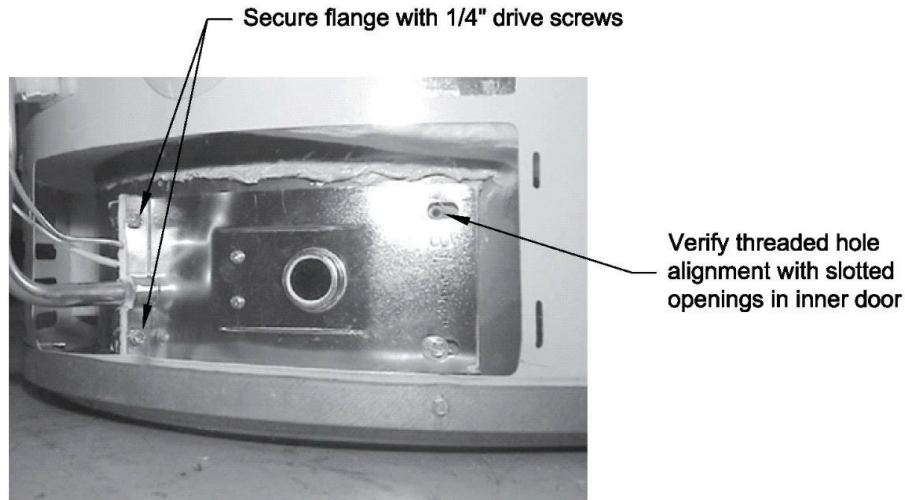

- Step 6. Reconnect the lead wires from combination thermostat/gas valve to resettable thermal switch (see photo in Step 3).
NOTE: Wire terminations are interchangeable with either resettable thermal switch connections.
- Step 7. Replace the outer jacket burner access door.
- Step 8. To resume operation, follow the instructions located on the lighting instruction label or the lighting instructions located in the Installation and Operation Manual.

CLOSED CIRCUIT THERMOCOUPLE TESTING (White Rodgers Mechanical)

- Step 1. Closed circuit testing is the preferred method for testing the thermocouple. Following the lighting instruction label on the heater, proceed to light the pilot and allow to operate for three minutes. If the pilot will not stay lit, hold the pilot button (located on the combination thermostat/gas valve) down during this test.
- Step 2. Using a multimeter capable of measuring millivolts, connect one lead using an alligator clip to the copper sheath of the thermocouple. Use the second lead of the multimeter to probe the top terminal located at the back of the combination thermostat/gas valve.
- Step 3. If meter reads 10 millivolts or higher, the thermocouple is O.K.. If reading is below 10 millivolts, replace the thermocouple.

Probe top terminal on
back of combination
thermostat/gas valve

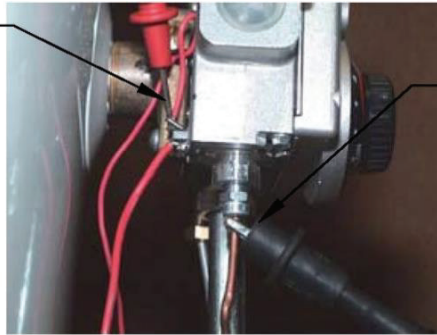

Alligator clip to copper
sheath of thermocouple

OPEN CIRCUIT THERMOCOUPLE TESTING (White Rodgers Mechanical)

Step 1. Disconnect the thermocouple from the combination thermostat/gas valve.

Step 2. Using a multimeter capable of measuring millivolts, connect one alligator clip to the end ball or contact portion of the thermocouple and the other alligator clip to copper portion of the thermocouple.



Step 3. Following the lighting instruction label on the heater, proceed to light the pilot and allow to operate for three minutes. **It will be necessary to hold the pilot button down continuously throughout this test.** A reading of 20 to 30 millivolts indicates good thermocouple output.

THERMOCOUPLE REPLACEMENT (White Rodgers Mechanical)

Step 1. Turn off gas supply to the water heater. Rotate the knob of the combination thermostat/gas valve to "OFF" position.

Depress knob slightly and rotate clockwise to the "OFF" position.



Step 2. Remove the outer jacket door.

Step 3. Remove the right side of inner door per Service Procedure RG-I, Steps 3a through 3c.

Step 4. Disconnect the thermocouple from the combination thermostat/gas valve. Locate other end of the thermocouple inside of the combustion chamber and remove from the pilot bracket. Pull firmly, pulling away from the pilot assembly.

Step 5. Install a new thermocouple into the pilot bracket making certain the thermocouple is fully engaged into the pilot bracket. Position the thermocouple against the left side inner door flange at its original position. Connect the other end of thermocouple to the combination thermostat/gas valve (finger tight + a 1/4 turn).

Thermocouple position

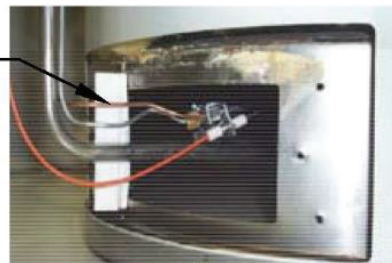

Step 6. Inspect the inner door gasket per Service Procedure RG-I, Step 4.

Step 7. Install right side inner door per Service Procedure RG-I, "Installation of Inner Door with Gasket," Step 6 through Step 8.

Step 8. To resume operation, follow the instructions located on the lighting instruction label or the lighting instructions located in the Installation and Operation Manual.

OPEN CIRCUIT THERMOPILE TESTING **(Resideo & White Rodgers Electronic)**

- Step 1. Turn knob to pilot position and depress.
- Step 2. Continue pressing knob and remove the red (+) wire from resettable thermal door switch.
- Step 3. Using a multimeter capable of measuring millivolts, connect the positive side of the multimeter to the terminal of the resettable thermal switch. Connect the negative side of the multimeter to any earth ground location (jacket base, screw, etc.). Normal thermopile operation will be between 350mV - 850mV.

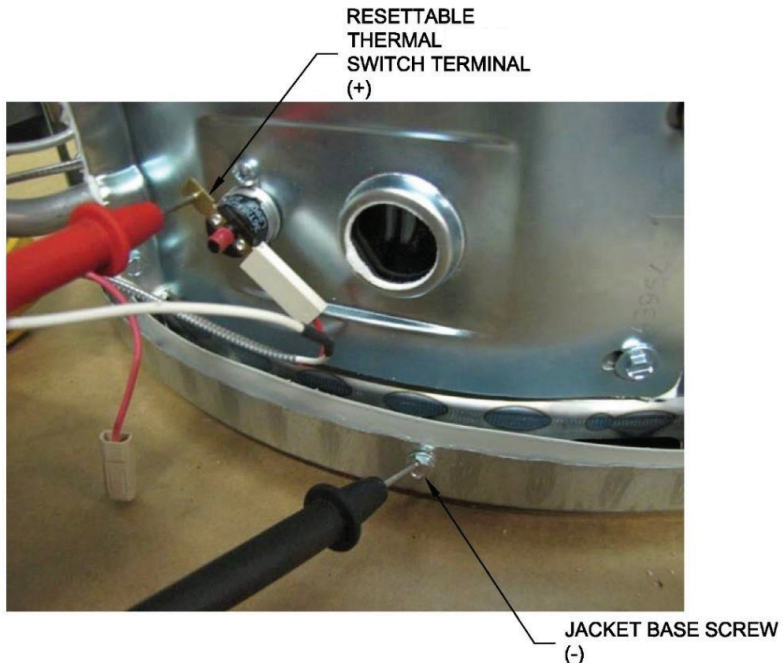

- Step 4. If reading is less than 350mV, resettable thermal switch must be tested. Refer to Service Process RG-III. If resettable thermal switch is closed, replacement of pilot assembly is recommended following Service Procedure RG-III.
- Step 5. If thermopile reading is between 350mV - 850mV, reconnect red wire to positive (+) terminal of the gas control.
- Step 6. Release the gas control knob and turn to desired setting to resume normal operation.

PILOT/ELECTRODE ASSEMBLY INSPECTION, CLEANING, AND REPLACEMENT

Step 1. Turn off gas supply to water heater. Rotate the knob of gas control/gas valve to the "OFF" position.

Step 2. Remove the outer jacket door.

Step 3. Remove right side of inner door per Service Procedure RG-I, Steps 3a through 3c.

Step 4. Disconnect thermocouple/thermopile, pilot tube, and feedline from gas control/gas valve.

NOTE: Feedline nut for natural gas control uses right hand threads, L.P. control uses left hand thread.

Step 5. Disconnect piezo ignition wire from piezo igniter.

Step 6. Remove burner assembly from the combustion chamber.

Step 7. Remove the pilot/electrode assembly from the feedline.

Step 8. Inspect pilot for the following:

- a) Primary air openings for blockage. Must be free from any debris (dirt, lint, etc.).
- b) Kinks or cracks in the pilot tube. If found, the pilot must be replaced.

Step 9. Inspect pilot orifice (**Resideo ONLY**):

- a) Remove 7/16" nut from bottom of pilot assembly.
- b) Remove pilot tube and pilot orifice.
- c) Inspect pilot orifice for blockage, must be cleaned or replaced. (Resideo & White Rodgers Electronic pilot orifice not replaceable, replace pilot assembly).

Step 10. Install pilot/electrode assembly to feedline, secure with screw from Step 7.

Step 11. Re-install burner assembly into combustion chamber, connect feedline, pilot tube and thermocouple/thermopile to gas control/gas valve.

Step 12. Install inner door per Service Procedure RG-I, "Installation of Inner Door with Gasket."

Step 13. To resume operation, follow the instructions located on the lighting instruction label or the lighting instructions located in the Installation and Operation Manual.

For Resideo & White Rodgers electronic control, rotate knob counter-clockwise to the "OFF" position.



For White Rodgers mechanical control, depress knob slightly and rotate clockwise to the "OFF" position.



Feedline nut



Primary air opening
White Rodgers pilot

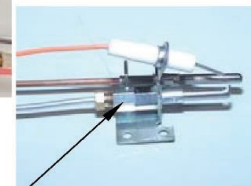

Primary air opening
Resideo pilot

PILOT ORIFICE

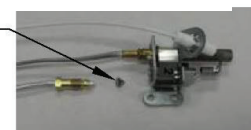

Removal of thermopile from Resideo & White Rodgers Electronic pilot assembly is **NOT** recommended but can be achieved by viewing the pilot assembly from the top and pressing the thermopile towards the right while pulling to remove.

PIEZO IGNITER, ELECTRODE TESTING AND REPLACEMENT

With the pilot not in operation (no pilot flame) you can check the piezo and electrode circuit by viewing pilot through the sight glass located on the inner door and observing the spark action.

- Step 1. Remove the outer jacket door.
- Step 2. Repeatedly depress the piezo igniter while viewing the pilot through the sight glass. If a spark is present, the circuit is O.K.. If there is no spark, proceed to Step 3.

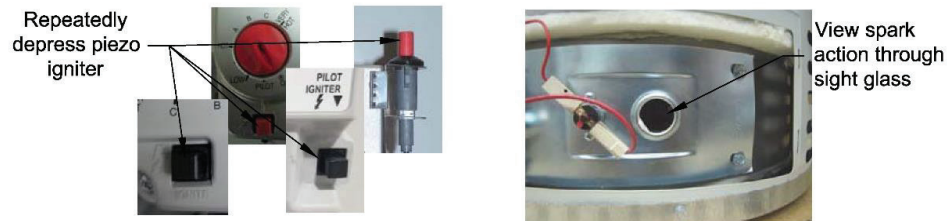

- Step 3. Remove orange (or white) wire from piezo igniter and install a jumper wire in its place. Hold the other end of the jumper by the wire insulation or using an insulated tool, next to an unpainted surface such as the feedline or gas valve and depress the piezo igniter. If there is a spark, the igniter is O.K., the pilot is not functioning and must be replaced (see Service Procedure RG-III for pilot replacement). If no spark is present the igniter is not functioning and must be replaced.

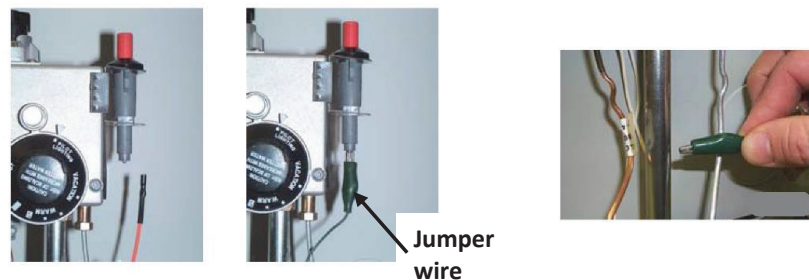

- Step 4a. **For White Rodgers Mechanical gas valves:** To replace the igniter, disconnect orange wire from piezo igniter. Use a flat-head screwdriver under piezo bracket and gently pry bracket from the front of the gas valve and unhook the bracket from rear of the gas valve.

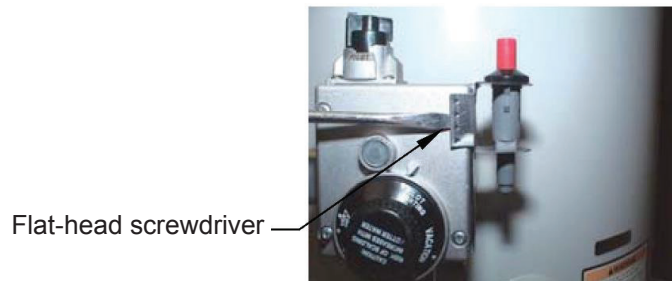

- Step 4b. **For ICON System gas controls:** To replace the igniter, see the Resideo ONLY information in Service Procedure RG-VI.

GAS VALVE TESTING AND REPLACEMENT (White Rodgers Mechanical)

The gas valve is a non-repairable device. If troubleshooting has determined a problem with the gas valve, it must be replaced.

If the burner and/or pilot do not function, service checks for gas pressure, thermocouple output, magnet assembly, and ECO are to be performed. If these check O.K., the gas valve may be faulty.

LINE PRESSURE

The gas valve is designed for a maximum line pressure of 14.0" W.C., and a minimum line pressure based on the manifold pressure plus 1.0" W.C. (check rating plate for rated manifold pressure). Line pressure must be checked with burner on and burner off to assure proper readings.

MANIFOLD PRESSURE TESTING

(This procedure assumes a maximum line pressure of 14.0" W.C.)

Step 1. Set gas valve to "OFF" position.

Step 2. Remove the pressure tap plug (3/16" Allen wrench) and install pressure tap.

Step 3. Connect the manometer to pressure tap.

Step 4. Follow the lighting instructions and proceed to light main burner and observe manometer reading.

Step 5. Proper operating range for natural gas is 4.0 \pm 0.5" W.C.
Proper operating range for L.P. gas is 10.0 \pm 0.5" W.C.

- a. If pressure is O.K., set gas valve to "OFF" remove manometer and pressure tap and replace pressure tap plug. Check for gas leaks before placing water heater back in operation.
- b. If pressure is out of the specification noted above, proceed to Step 6 for proper service procedure.

Step 6. The manifold pressure is **NOT** adjustable. If manifold pressure is outside of the range in Step 5, the control must be replaced.

Pressure tap
shown installed

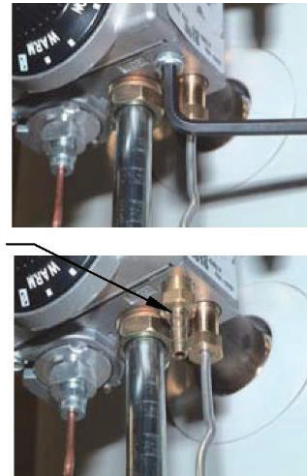

MAGNET ASSEMBLY TESTING (White Rodgers Mechanical Control)

- Step 1. Following the lighting instruction label on the heater, proceed to light the pilot and allow to operate for three minutes. If the pilot will not stay lit, hold the pilot button (located on the gas valve) down during this test.
- Step 2. Using a multimeter capable of measuring millivolts, connect one lead using an alligator clip to the copper sheath of the thermocouple. Use the second lead of the multimeter to probe the top terminal located at the back of the gas valve.

Probe top terminal on
back of combination
thermostat/gas valve

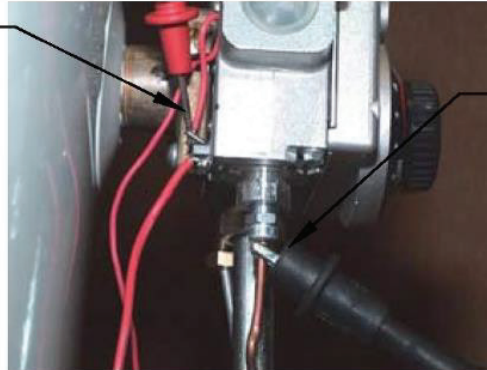

Alligator clip to copper
sheath of thermocouple

- Step 3. With a meter reading of 13 millivolts or greater, rotate the knob of the combination thermostat/gas valve to the "OFF" position.
- Step 4. The magnet should remain closed for a drop of at least 6 millivolts. You will hear a "snap" or "click" sound when the magnet opens; if you hear this sound prior to a drop of 6 millivolts, the magnet is out of specification and the gas valve should be replaced.

ECO (ENERGY CUT OFF) TESTING

- Step 1. Disconnect the thermocouple from the gas valve.
- Step 2. Using a multimeter capable of measuring ohms (or continuity), attach one lead using an alligator clip to the pilot tube. Insert the other lead fully into the magnet opening, be sure the lead makes contact only at the top center of the magnet opening. **DO NOT** allow the lead to make contact with the threaded sides of the opening.

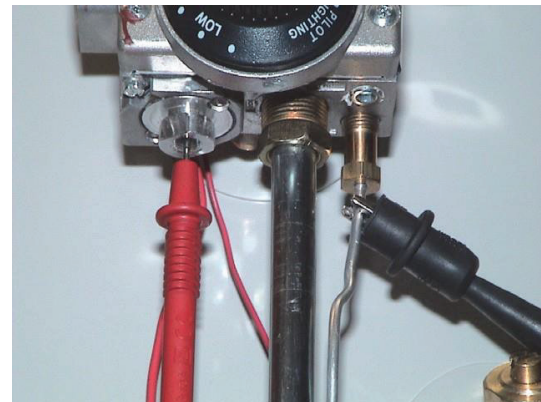

- Step 3. If continuity is indicated, the ECO is O.K.. If continuity is not indicated, the ECO has opened, and the gas valve must be replaced.

COMBINATION THERMOSTAT/GAS VALVE REPLACEMENT

- Step 1. Rotate the knob of the gas valve to the "OFF" position.
- Step 2. Turn off gas supply to the water heater.
- Step 3. Disconnect the gas supply line from the gas valve.
- Step 4. Turn off water supply and drain the water heater completely.
- Step 5. Remove the outer jacket burner access door.

For White Rodgers Control, depress knob slightly and rotate clockwise to the "OFF" position.



Step 6. Right side inner door removal:

- a) Disconnect resettable thermal switch wire leads (leading from gas valve) and remove the wire tie from the feedline.
- b) Remove two (2) 1/4" hex drive screws from the right side inner door.
- c) Remove two (2) 1/4" hex drive screws from the flange section of inner door.
- d) Remove the right side inner door and set aside. Be careful to not damage the gasket material on the inner door.

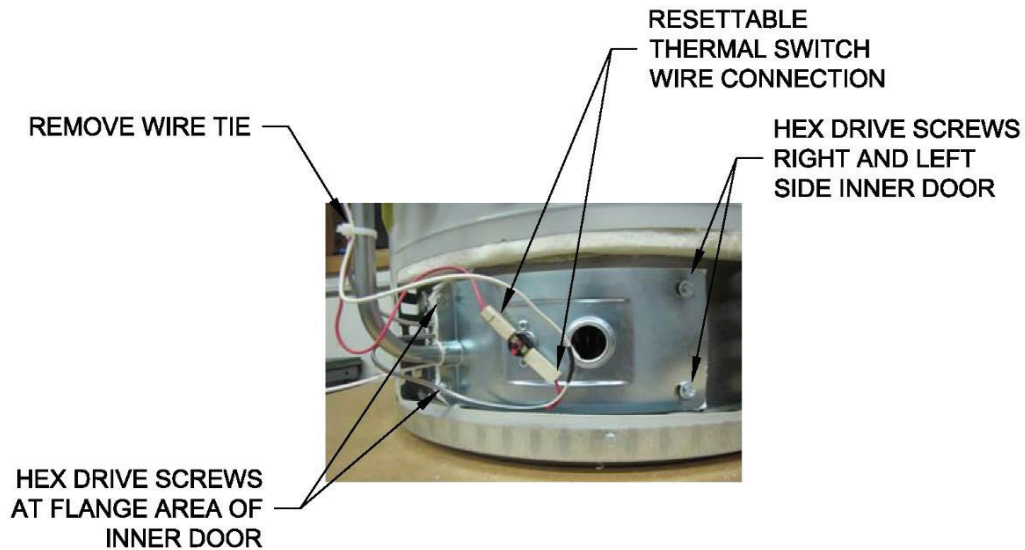

Step 7. Removal of gas valve:

- a) Disconnect the main burner feedline, pilot tube and thermocouple from the gas valve. Remove the burner from combustion chamber.

NOTE: Feed line nut for natural gas control uses right hand threads; L.P. control uses left hand thread.

- b) Remove piezo bracket with piezo igniter (refer to Service Procedure RG-IV) from gas valve.
c) Remove gas valve from water heater, rotating counter clockwise using a control body wrench or a length of 1/2" NPT pipe threaded into inlet of control.

To remove or install control, insert only 1/2" NPT threaded pipe into inlet and use to loosen or tighten control

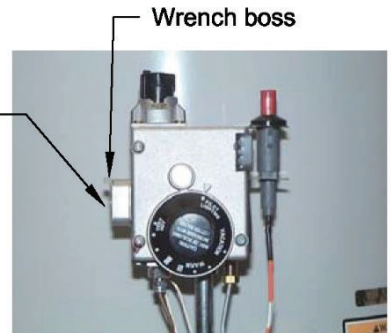

Step 8. Installation of gas valve:

- a) Install new gas valve using a control body wrench or a length of 1/2" NPT pipe threaded into inlet of control. **DO NOT OVER TIGHTEN.** Use caution not to damage cast aluminum body of gas valve. Be certain not to damage the bundled wire leads.

NOTE: Gas valve must be installed in proper upright position to assure the feedline will align properly at the inner door flange. **DO NOT OVER TIGHTEN.** If control is turned past proper alignment, **DO NOT** reverse direction to align.

- b) Reattach piezo bracket with piezo igniter to gas valve.
c) Reattach main burner feedline, pilot tube and thermocouple to gas valve.

NOTE: Feedline nut for natural gas control uses right hand threads; L.P. control uses left hand thread.

- d) Gather wire leads of gas valve and piezo igniter and secure alongside of feedline using new wire tie provided.
e) Connect gas supply piping to inlet of control. Use back up wrench on wrench boss of control, **NEVER** use back up wrench on body of control.

Step 9. Reinstallation of inner door assembly:

- a) Prior to reinstallation of inner door, fully inspect inner door gasket for the following:

- Tears
- Missing material
- Cracks
- Dirt or debris
- Gasket adhesion to inner door
- Other imperfections that will inhibit proper seal
- Material left on combustion chamber

If the gasket is not affected by any of the above, gasket replacement will not be required. If replacement is required, replace using new gasket kit following the provided instructions.

Step 9. Reinstallation of inner door assembly (cont.):

- b) Clean any gasket residue or other debris from combustion chamber surface before installing the inner door/gasket assembly.
- c) Position thermocouple, pilot tube and piezo wire against left side inner door flange gasket. **DO NOT ROUTE THROUGH RADIUS CHANNEL WITH FEEDLINE.** Be sure that thermocouple and pilot tube are not in position to interfere with outer jacket burner access door when reinstalled.

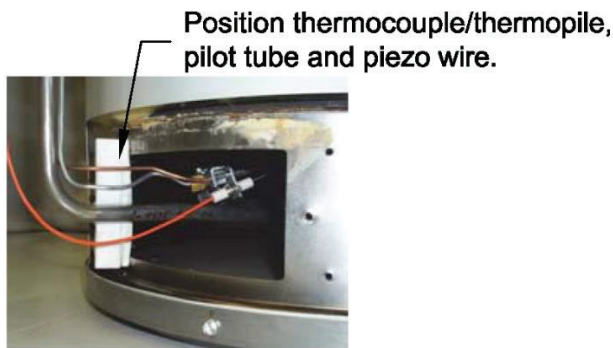

- d) Firmly place the right side inner door flange against the left side inner door flange and secure with two (2) hex drive screws from Step 6c. **DO NOT OVER TIGHTEN SCREWS.**
- e) Align the right side inner door to combustion chamber and verify the fastener holes of the combustion chamber are aligned with the right-side inner door slotted openings. Verify seal integrity around the combustion opening. Secure right-side inner door using two (2) hex drive screws from Step 6b. **DO NOT OVER TIGHTEN SCREWS.** Verify both left and right sides of the inner door are properly positioned and sealed against the combustions chamber.

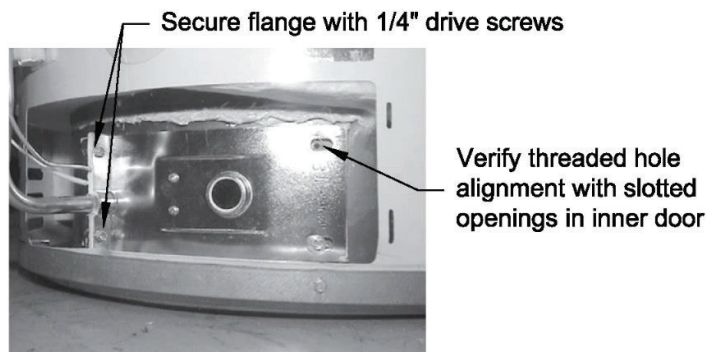

Step 10. Reconnect wire leads from gas valve to resettable thermal switch (see photo in Step 6).
NOTE: Wire terminations are interchangeable with either resettable thermal switch connection.

Step 11. Replace the outer jacket burner access door.

Step 12. Reconnect the gas supply to the gas valve.

Step 13. Resume water supply to the water heater. Be sure the tank is full of water.

Step 14. To resume operation, follow the instructions located on the lighting instruction label or the lighting instructions located in the Installation and Operation Manual.

LINE PRESSURE

The gas valve is designed for a maximum line pressure of 14.0" W.C., and a minimum line pressure based on the manifold pressure plus 1.0" W.C. (check rating plate for rated manifold pressure). Line pressure must be checked with burner on and burner off to assure proper readings.

MANIFOLD PRESSURE TESTING

(This procedure presumes a maximum line pressure of 14.0" W.C.)

- Step 1. Set the gas control to the "OFF" position.
- Step 2. Remove pressure tap plug (3/16" allen wrench) and install 1/8" NPT pipe, coupling, and pressure tap.
- Step 3. Connect manometer to pressure tap.
- Step 4. Follow instructions located on the lighting instructions label and proceed to light the main burner and observe manometer reading.
- Step 5. Proper operating range for natural gas is:
4.0" \pm 0.5" W.C.
Proper operating range for L.P. gas is:
10.0" \pm 0.5" W.C.
 - a) If pressure is within the range specified in the previous step, set gas control knob to the "OFF" position, remove manometer and pressure tap, and replace pressure tap plug. Check for gas leaks prior to placing water heater back into operation by following the instructions located on the lighting instruction label or the lighting instructions located in the Installation and Operation Manual.
 - b) If gas pressure is outside the specification noted above, refer to the following Resideo ONLY information, or "Gas Control Replacement" to replace gas control or valve body.
- Step 6. The manifold pressure is NOT adjustable. If manifold pressure is outside of the range in Step 5, the control must be replaced.



Gas controls shown in the "OFF" position

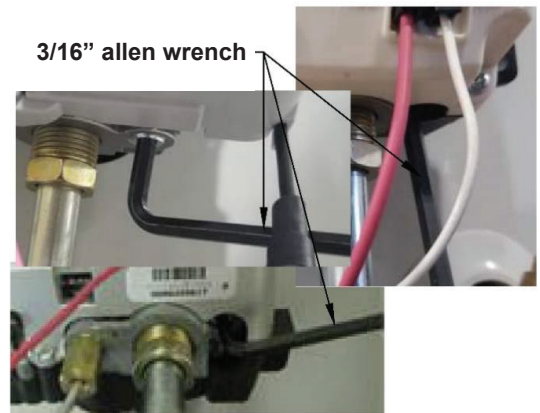

3/16" allen wrench



Pressure tap shown installed

ECO (ENERGY CUT OFF) TESTING

The Resideo and White Rodgers Electronic gas control is designed with an ECO device that will reset.

To reset the gas control after a status code 4, turn the gas control knob to the "OFF" position and wait a minimum of five (5) minutes before relighting following the instructions located on the lighting instruction label or the lighting instructions located in the Installation and Operation Manual.

NOTE: The following procedure applies to the ICON System gas control ONLY.

ICON System COVER REMOVAL

- Step 1. Rotate the knob of the gas control to the "OFF" position.
- Step 2. Turn off gas supply to the water heater.
- Step 3. Disconnect the gas supply line from the gas control.
- Step 4. Disconnect the piezo igniter wire.
- Step 5. Remove the gas control cover screw using flat-head screwdriver.

⚠ CAUTION

Use caution to not bend or damage valve body pins when removing or installing the gas control cover.



Rotate knob counter-clockwise to the "OFF" position



Gas control cover screw

- Step 6. Depress both tabs on the top of the gas control cover and pull straight out to remove.

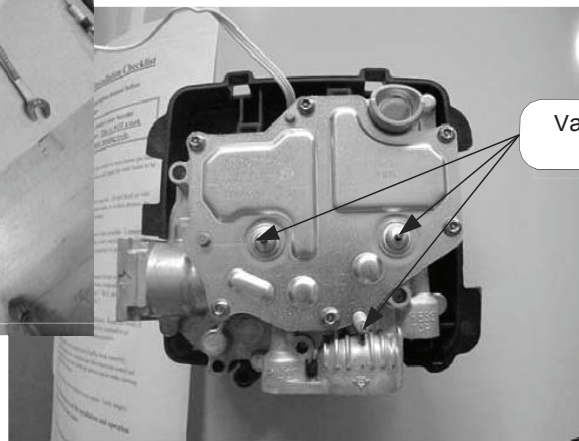

Valve body pins

ICON System COVER REMOVAL (cont.)

Step 7. Disconnect the temperature sensor from the control board and remove the wire from the temperature sensor wire routing clip.

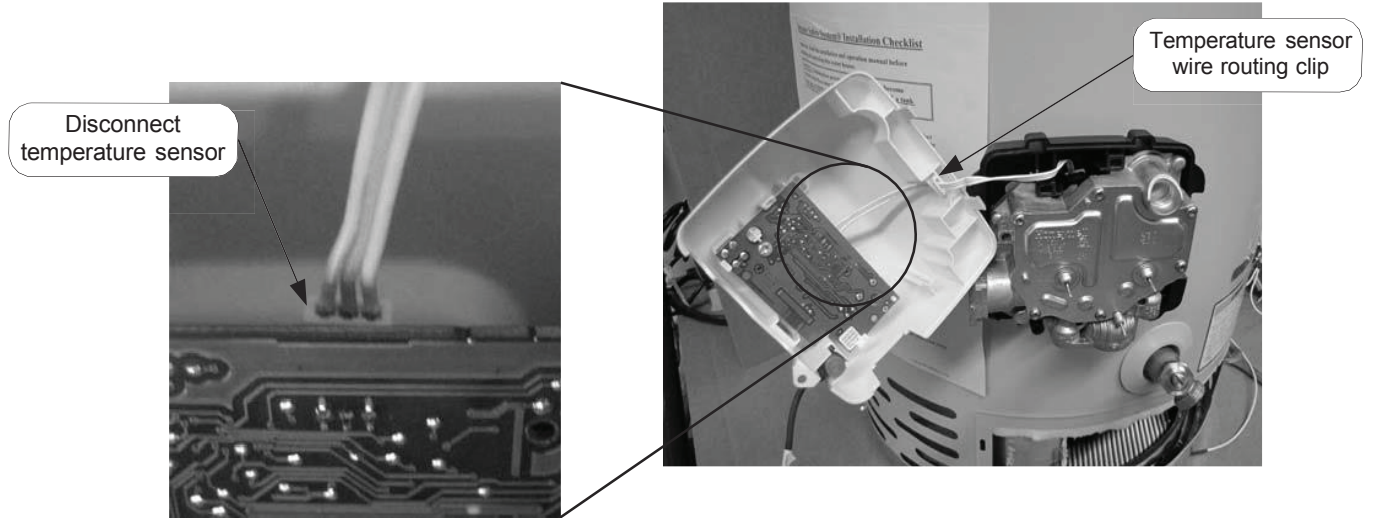

Step 8. Remove the piezo igniter from the control cover by releasing the lock tab on the control cover.

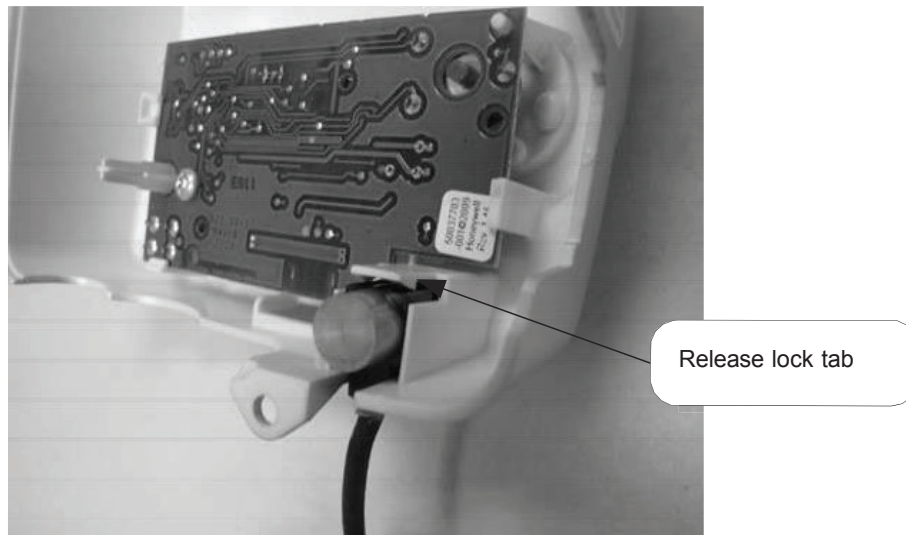

ICON System VALVE BODY REMOVAL AND TEMPERATURE SENSOR REMOVAL

Step 1. Disconnect the burner and pilot tubes per Service Procedure RG-II.

Step 2. Remove the valve body by removing the screw located at the lower left corner. Unclip the lower right side from the backplate first, followed by the lower left side, using a flat-head screwdriver.

⚠ CAUTION

Use caution to not bend or damage valve body pins.

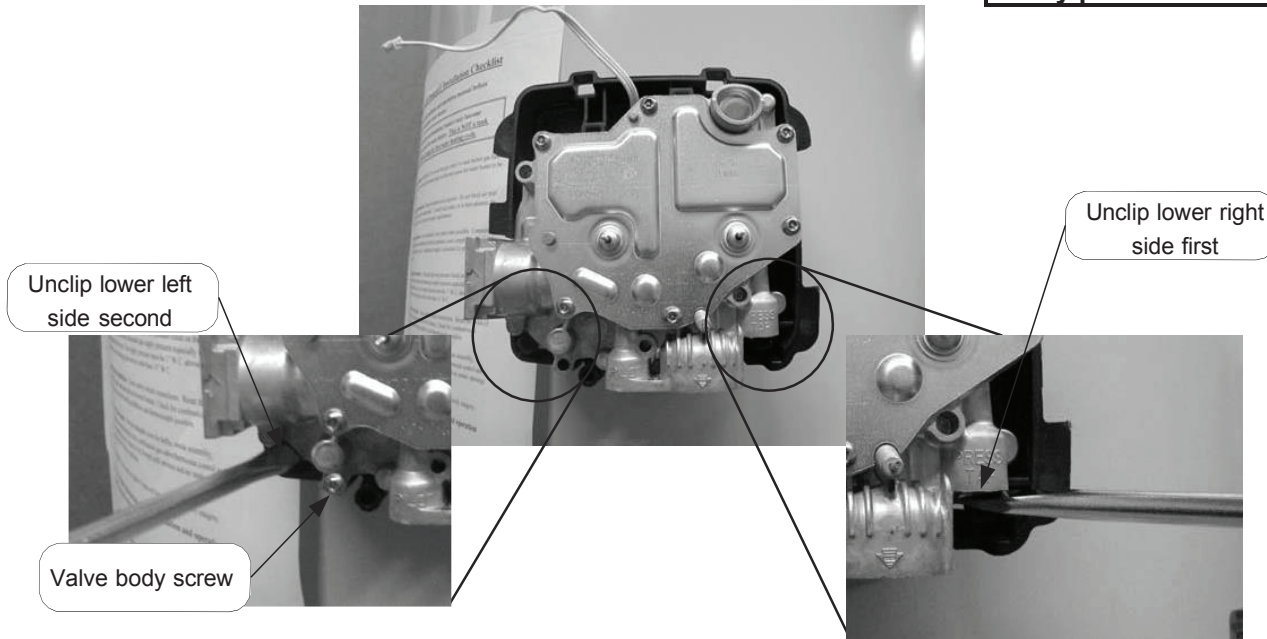

Step 3. Remove the temperature sensor and insertion stick from the backplate by first removing the wire from the temperature sensor wire routing clips. Make note of the insertion stick's orientation, as the insertion stick can only be installed in one way.

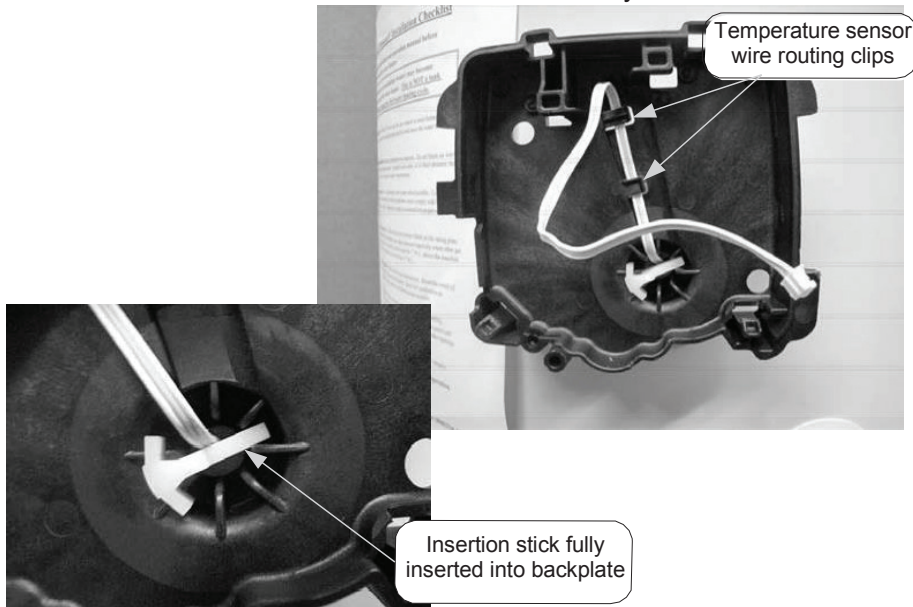

⚠ CAUTION

When reinstalling temperature sensor and insertion stick, make sure the assembly is inserted FULLY into the backplate and the wires are routed through the wire routing clips. Failure to do so will not allow the valve body to be reinstalled properly and may damage temperature sensor wires.

ICON System VALVE BODY REMOVAL AND TEMPERATURE SENSOR REMOVAL (cont.)

Step 4. Remove the temperature sensor from the insertion stick by pulling apart as illustrated below.

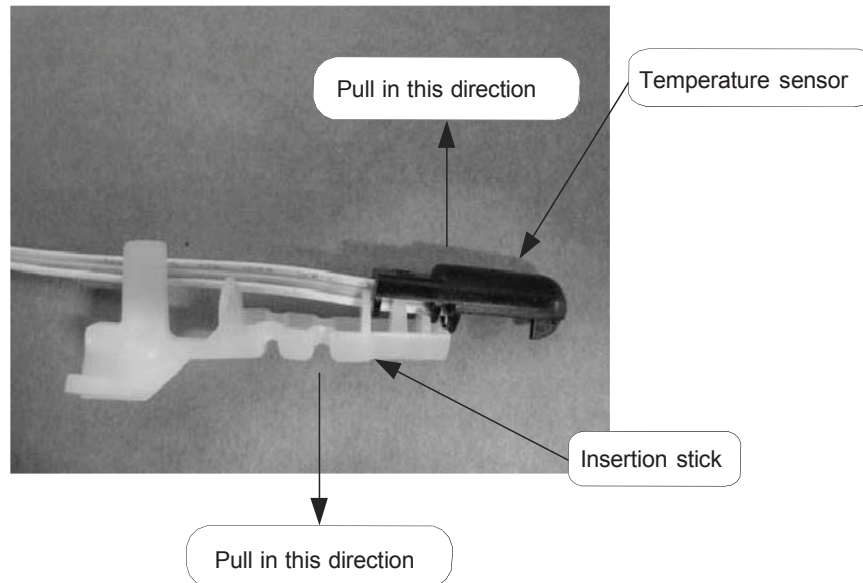

Step 5. To reassemble the gas control, follow the previous steps in reverse order. Once the gas control is reassembled, the burner assembly is reinstalled, and the gas supply line is reconnected, resume water supply to the water heater. Be sure the tank is full of water before relighting.

Step 6. To resume operation, follow the instructions located on the lighting instruction label, or the lighting instructions located in the Installation and Operation Manual.

TEMPERATURE SENSOR TESTING (Resideo)

Step 1. If control has gone into lockout due to excessive tank temperature (four flashes, three second pause), reset control by rotating gas control knob to "OFF" position and wait a minimum of five (5) minutes. Then follow lighting instructions and return the gas control knob to a desired setpoint.

Step 2. Observe green light indicator. Does status code 4 (four flashes, three second pause) appear?
a) If no, resume normal operation.
b) If yes, continue with Step 3.

Step 3. Following "ICON System Cover Removal," "ICON System Valve Body Removal and Temperature Sensor Removal" instructions, disassemble gas control to access the temperature sensor.

Step 4. With the temperature sensor still in the back plate, use a multimeter set to the ohms setting, determine the resistance of the temperature sensor (see photo).

Step 5. See next page to obtain water temperature. Are temperature sensor resistance values correct?
a) If no, replace the temperature sensor.
b) If yes, replace the gas control.

⚠ CAUTION

DO NOT use standard multimeter probes for this test. Doing so will damage connector. Use special pin type electronic probes or small diameter wire pins inserted into connector.

NOTE: Using a multi-meter set to the ohms setting, insert one-meter probe into center wire position of thermal well connector, insert the second probe into either of the outside wire positions (see photo).

Alternate the probe on the outside position to the opposite outside wire position (see photo).

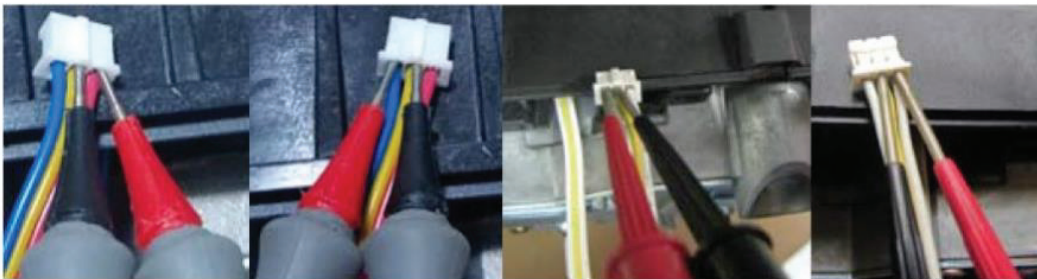

⚠ WARNING
Stored water may be HOT when performing the following steps in this procedure. Take necessary precaution to prevent personal injury.

DETERMINE WATER TEMPERATURE

NOTE: It is important to understand once the resistance for the temperature sensor is determined from the previous page, water flow through the water heater should not occur. Prior to drawing water from drain valve, turn off the cold-water supply to the water heater. This will prevent cold water flow into the tank, affecting the resistance value of the temperature sensor.

- Step 1. Set the gas control knob to the “OFF” position. Turn off inlet water supply to water heater.
- Step 2. Draw approximately 4 gallons of water from drain valve into a container, or suitable drain, and discard. Draw an additional gallon and immediately measure water temperature using an accurate thermometer. It may be necessary to open a hot water faucet to allow water heater to drain.
- Step 3. Using the chart below, determine correct resistance value for the water temperature from Step 2.

Example: If temperature of water is 84°F, then the resistance through the sensor would be 8449 (see shaded area).

NOTE: Sensor resistance increases as the temperature decreases.

Sensor Resistance at Various Temperatures

In Degrees F										
°F	0	1	2	3	4	5	6	7	8	9
40	26109	25400	24712	24045	23399	22771	22163	21573	21000	20445
50	19906	19383	18876	18383	17905	17440	16990	16553	16128	15715
60	15314	14925	14548	14180	13823	13477	13140	12812	12494	12185
70	11884	11592	11308	11032	10763	10502	10248	10000	9760	9526
80	9299	9078	8862	8653	8449	8250	8057	7869	7685	7507
90	7333	7165	7000	6839	6683	6531	6383	6238	6098	5961
100	5827	5697	5570	5446	5326	5208	5094	4982	4873	4767
110	4663	4562	4464	4368	4274	4183	4094	4006	3922	3839
120	3758	3679	3602	3527	3453	3382	3312	3244	3177	3112
130	3048	2986	2925	2866	2808	2752	2697	2643	2590	2538
140	2488	2439	2391	2344	2298	2253	2209	2166	2124	2083
150	2043	2004	1966	1928	1891	1856	1820	1786	1753	1720
160	1688	1656	1625	1595	1566	1537	1509	1481	1454	1427
170	1402	1376	1351	1327	1303	1280	1257	1235	1213	1191
180	1170	1150	1129	1110	1090	1071	1053	1035	1017	999
190	982	965	949	933	917	901	886	871	857	842
200	828	814	801	788	775	762	749	737	725	713

GAS CONTROL REPLACEMENT

Step 1. Rotate knob of the gas control to the "OFF" position.

Step 2. Turn off gas supply to the water heater.

Step 3. Disconnect the gas supply line from gas control.

Step 4. Turn off the water supply and drain the water heater completely.

Step 5. Remove the outer jacket burner access door.

Step 6. Right side inner door removal:

- Disconnect the red wire leads from the resettable thermal switch.
- Remove two (2) 1/4" hex drive screws from RIGHT side inner door.
- Remove two (2) 1/4" hex drive screws from FLANGE SECTION of inner door.
- Remove the right side inner door and set aside. Be careful to not damage gasket material on inner door.

Rotate knob counter-clockwise to the "OFF" position.

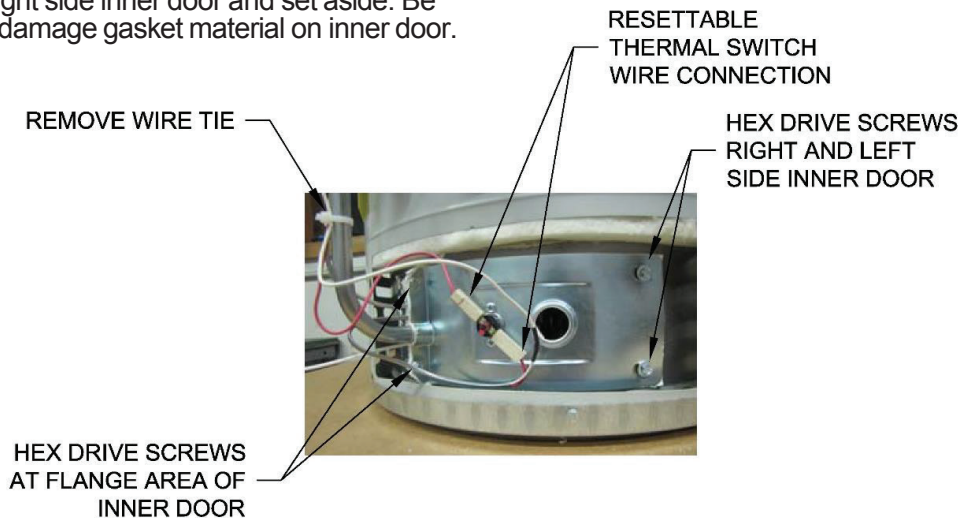

Step 7. Removal of gas control:

- Disconnect main burner feedline, pilot tube, piezo igniter wire, inner door wire (red), and thermopile wire (white) from gas control.
- Remove gas control from water heater by rotating counter clockwise. **DO NOT** use a wrench on the gas control body, damage to the gas control may occur. If necessary, use a length of 1/2" NPT pipe threaded into gas inlet of gas control.

Step 8. Install new gas control into water heater:

- Install a new gas control into water heater by rotating clockwise. **DO NOT** use a wrench on the gas control body, as damage to the gas control may occur. If necessary, use a length of 1/2" NPT pipe threaded into gas inlet of gas control.

GAS CONTROL REPLACEMENT (cont.)

Step 8. Install new gas control into water heater (cont.):

- b) Reattach the main burner feedline, pilot tube, piezo igniter wire, inner door wire (red), and thermopile wire (white) to the gas control. Attach the inner door wire (red) to the positive (+) terminal and the thermopile wire (white) to the negative (-) terminal.

⚠ CAUTION

Use back up wrench on wrench boss of gas control, **NEVER** use back up wrench on body of gas control.

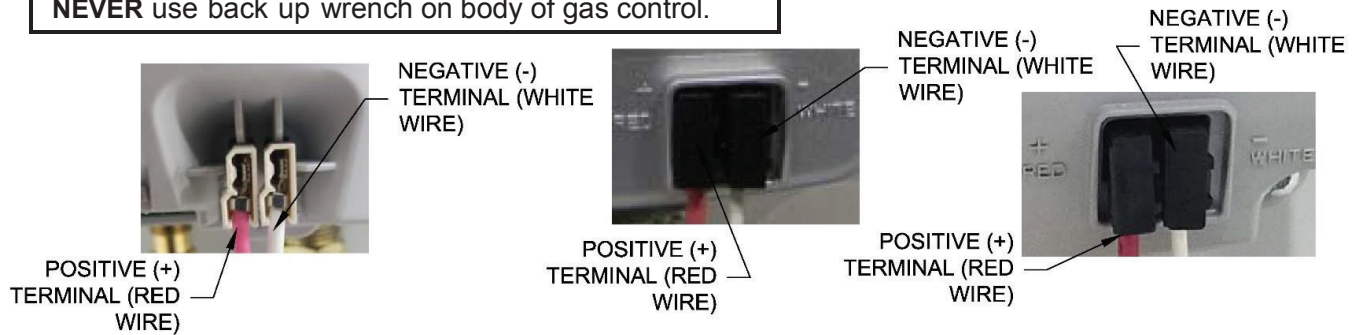

- c) Gather piezo igniter wire, thermopile wire (white), inner door wire (red), and pilot alongside of feedline using new wire tie provided.
 d) Reconnect gas supply piping to inlet of gas control.

Step 9. Reinstallation of inner door assembly:

- a) Prior to reinstallation of inner door, fully inspect inner door gasket for the following:
- Tears
 - Missing material
 - Cracks
 - Dirt or debris
 - Gasket adhesion to inner door
 - Material left on combustion chamber
 - Other imperfections that will inhibit proper seal

If the gasket is not affected by any of the above, gasket replacement will not be required. If replacement is required, replace using new gasket kit following the instructions provided with kit.

- b) Clean any gasket residue or other debris from combustion chamber surface before installing the inner door/gasket assembly.
- c) Position thermopile wire, pilot tube, and piezo wire against left side inner door flange gasket. **DO NOT ROUTE THROUGH RADIUSED CHANNEL WITH FEEDLINE.** Be sure that the thermopile and pilot tube are not in position to interfere with outer jacket burner access door when reinstalled.

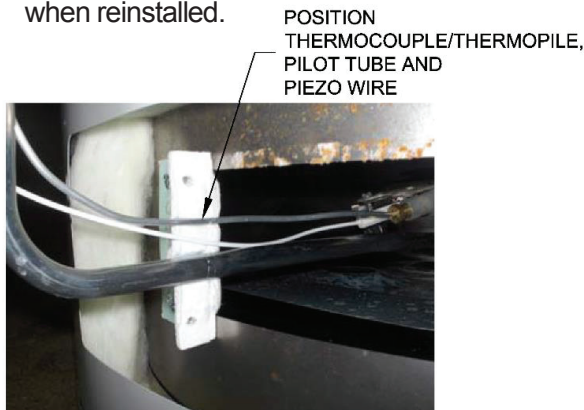

⚠ WARNING

A seal breach may result in a fire or explosion causing property damage, personal injury or death.

GAS CONTROL REPLACEMENT (cont.)

Step 9. Reinstallation of inner door assembly (cont.):

- d) Firmly place right side inner door flange against the left side inner door flange and secure with two (2) 1/4" hex drive screws from Step 6c. **DO NOT OVER TIGHTEN SCREWS.**
- e) Align the right side inner door to combustion chamber and verify the fastener holes of the combustion chamber are aligned with the right side inner door slotted openings. Verify seal integrity around the combustion opening. Secure right side inner door using two (2) 1/4" hex drive screws from Step 6b. **DO NOT OVER TIGHTEN SCREWS.** Verify both left and right sides of the inner door are properly positioned and sealed against the combustion chamber.

⚠ CAUTION
Use back up wrench on wrench boss of gas control, **NEVER** use back up wrench on body of gas control.

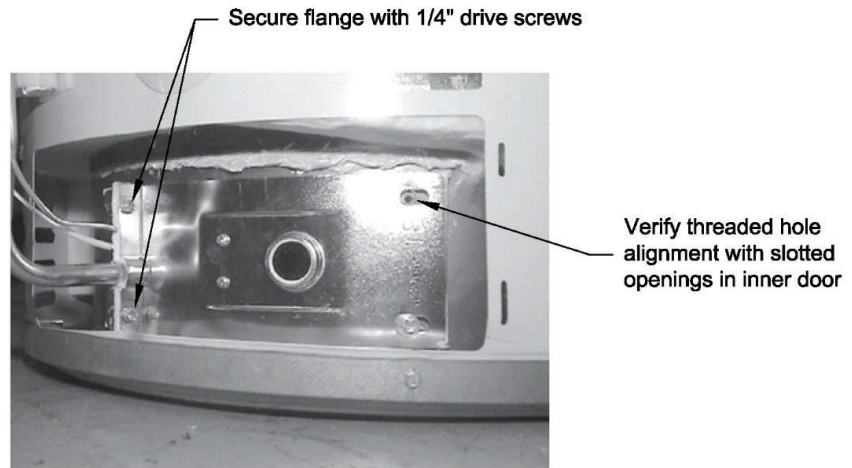

- Step 10. Reconnect two (2) red wire leads from pilot assembly and gas control to resettable thermal switch.
NOTE: wire terminations are interchangeable with either resettable thermal switch connection.
- Step 11. Replace the outer jacket burner access door.
- Step 12. Reconnect the gas supply to gas control.
- Step 13. Resume water supply to the water heater. Be sure the tank is full of water before resuming operation.
- Step 14. To resume operation, follow the instructions located on the lighting instruction label or the lighting instructions located in the Installation and Operation Manual.

MAIN BURNER: Inspection, Adjustment, Cleaning and Replacement

At periodic intervals (not more than 6 months) a visual inspection should be made of the main burner for proper operation and to ensure no debris accumulation.

Main burner should light smoothly from pilot and burn with a blue flame with a minimum of yellow tips.

Steel burner models have a self-adjusting air mixture and do not have an adjustable air shutter.

Main burner must be free from any debris accumulation that may affect burner operation (see burner cleaning procedure on page 36).

⚠ DANGER

Under **NO** circumstances should flammable materials be used or stored in the vicinity of the water heater. With the inner door removed the Bradford White Defender Safety System will be deactivated. If flammable vapors are present, a fire or explosion may result causing property damage, personal injury, or death.

⚠ WARNING

Inner door and burner components may be **HOT** when performing this operation. Take necessary precaution to prevent personal injury.

BURNER REMOVAL

Step 1. Remove inner door assembly per Service Procedure RG-I, Steps 1 through 3c.

Step 2. Disconnect the main burner feed line, pilot tube and thermocouple/thermopile from combination thermostat gas valve and remove burner assembly from combustion chamber.

NOTE: Feedline nut for natural gas control uses right hand threads;
L.P. control uses left hand thread.

Step 3. Thoroughly inspect burner surface area and burner ports and remove any loose debris accumulation.



**BURNER SURFACE
AREA**

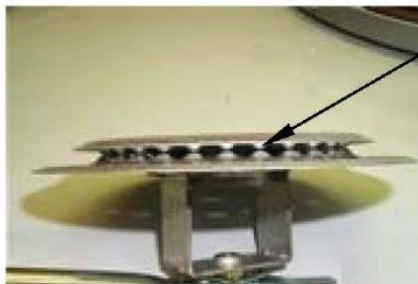

BURNER PORT AREA

BURNER CLEANING

Step 4. Disconnect the burner plate from main burner orifice and disconnect feedline from burner.



Step 5. Remove main burner orifice from feed line. Inspect and clean if necessary.



- Step 6. Remove pilot assembly, refer to Service Procedure RG-III for cleaning and inspection.
- Step 7. Using a stiff brush and compressed air, clean the burner plate and feedline, then reassemble all components.
- Step 8. Inspect combustion chamber area of heater prior to reinstallation of burner assembly. If cleaning is required, refer to Service Procedure RG-VIII.
- Step 9. Reinstall burner assembly into combustion chamber, reconnect feedline, thermocouple and pilot tube to the combination thermostat/gas valve.
- Step 10. Reinstall inner door per Service Procedure RG-I.
- Step 11. To resume operation, follow the instructions located on the lighting instruction label or the lighting instructions located in the installation and operation manual.

RESETTABLE THERMAL SWITCH CONTINUITY TESTING

- Step 1. Remove the outer jacket door.
- Step 2. Disconnect the wire leads from the resettable thermal switch.



- Step 3. Using a multimeter capable of measuring continuity (ohms), place one probe of meter on one of the brass connection tabs of the resettable thermal switch, and the remaining probe on the other connection tab.

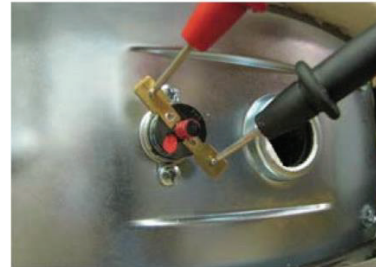

- Step 4. If continuity is indicated, the switch is closed, allowing millivolt current to pass.
- Step 5. If continuity is not indicated, the switch is open, possibly due to an overheating condition. The switch is designed to open at predetermined temperatures depending on model. An open switch can be reset by depressing the red colored button located at the center of the switch. The overheating condition must be determined prior to putting the heater back in service.

<u>PROBABLE CAUSE FOR RESETTABLE THERMAL SWITCH ACTIVATION</u>	
<u>PROBABLE CAUSE</u>	<u>PROBABLE CAUSE</u>
Insufficient combustion air	1. Verify adequate combustion air supply is available. 2. Clear jacket slot openings of any dirt, dust, restrictions or other obstructions. 3. Inspect flame arrestor plate and clean with a stiff brush, compressed air to remove scale deposits and debris.
1. Weak switch or switch out of calibration. 2. Incorrect switch.	1. Replace resettable thermal switch. 2. Verify switch color code and approximate temperature.
Flammable vapor incident	1. Replace water heater.

Resettable thermal switch color code reference	
Color code	Approximate switch activation temperature (open)
Blue	240°
Yellow	270°
Red	290°

RESETTABLE THERMAL SWITCH REPLACEMENT

Step 1. Rotate the knob of combination thermostat/gas valve to the "OFF" position.

For Resideo & White Rodgers electronic control, rotate knob counter-clockwise to the "OFF" position.



For White Rodgers mechanical control, depress knob slightly and rotate clockwise to the "OFF" position.



Step 2. Remove the outer jacket door.

Step 3. Disconnect the wire leads from the resettable thermal switch.



Step 4. Remove the resettable thermal switch from the inner door (Phillips screwdriver).



Step 5. Put new resettable thermal switch in place. Be sure contact surface of resettable thermal switch and inner door are free of any debris. Secure resettable thermal switch into place using screws from Step 4. **DO NOT OVER TIGHTEN SCREWS.**

Step 6. Reconnect wire leads from combination thermostat/gas valve to resettable thermal switch.

NOTE: Wire terminations are interchangeable with either resettable thermal switch connection.

Step 7. Replace the outer jacket door.

Step 8. To resume operation, follow the instructions located on the lighting instruction label or the lighting instruction located in the Installation and Operation Manual.

ScreenLok® Flame Arrestor Cleaning

Step 1. Rotate knob of combination thermostat gas valve to the off position.

For White Rodgers control, depress knob slightly and rotate clockwise to the "OFF" position.

For Resideo & White Rodgers electronic control, rotate knob counter-clockwise to the "OFF" position.

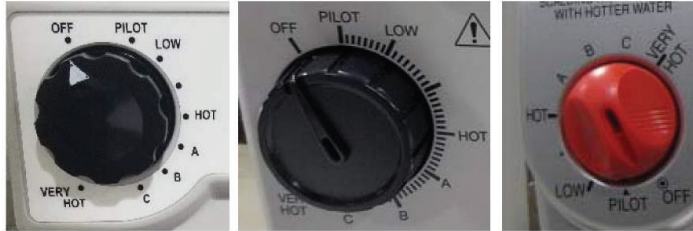

Step 2. Remove the outer jacket door.

Step 3. Remove inner door per Service Procedure RG-I, Steps 3a through 3e.

Step 4. Disconnect the main burner feed line, pilot tube, and thermocouple/thermopile from combination thermostat gas valve and remove burner assembly from the combustion chamber.

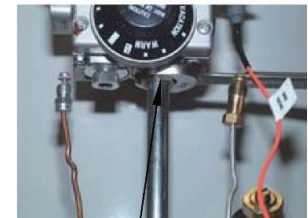

NOTE: Feedline nut for natural gas control uses right hand threads; Feedline nut —
L.P. control uses left hand thread.

Step 5. Clean ScreenLok® Flame Arrestor using stiff brush and compressed air to remove any scale or other debris accumulation. Using a soft brush, clear jacket openings of any dirt, dust, restrictions, or other obstructions.

Step 6. Remove any debris from burner assembly per Service Procedure RG-V and reinstall burner assembly into combustion chamber.

Step 7. Reconnect feedline, thermocouple, and pilot tube to the combination thermostat/gas valve.

Step 8. Reinstall inner door per Service Procedure RG-I.

Step 9. To resume operation, follow the instructions located on the lighting instruction label or the lighting instruction located in the Installation and Operation Manual.

DIPTUBE INSPECTION AND REPLACEMENT

⚠ WARNING

Heater components and stored water may be HOT when performing the following steps in this procedure. Take necessary precaution to prevent personal injury.

Step 1. Rotate the knob of combination thermostat/gas valve to "OFF" position.

For Resideo & White Rodgers electronic control, rotate knob counter-clockwise to the "OFF" position.



For White Rodgers mechanical control, depress knob slightly and rotate clockwise to the "OFF" position.



Step 2. Turn off cold water supply to the water heater. Connect a hose to the drain spigot of the water heater and route to an open drain. Open a nearby hot water faucet to vent the heater for draining. Open drain spigot of the water heater and allow the heater to drain to a point below the inlet connection nipple.

Step 3. Disconnect the inlet nipple from plumbing system.

Step 4. With an appropriate wrench, remove the inlet nipple/dip tube from the water heater. Use caution to not damage pipe threads.

Step 5. Visually inspect inlet nipple/dip tube. Inlet nipple/dip tube should be free of cracks and any blockage. Hydro-jets located near the bottom of the dip tube should be open and free of any blockage. The anti-siphon hole, located approximately 6 in from the bottom of nipple, should be free of any blockage.

Any damage such as cracks, restriction due to deformation or unintentional holes are not field repairable and the inlet nipple/dip tube must be replaced.

Step 6. Upon completion of inspection or subsequent replacement, reinstall the inlet nipple/dip tube into the heater. Ensure pipe dope is used on the nipple's threads. Connect the nipple to the plumbing system, resume the water supply, and refill the heater with water.

Step 7. To resume operation, follow the instructions located on the lighting instruction label or the lighting instructions located in the Installation and Operation Manual.

ANODE INSPECTION AND REPLACEMENT

⚠ WARNING

Heater components and stored water may be HOT when performing the following steps in this procedure. Take necessary precaution to prevent personal injury.

- Step 1. Turn off water supply to water heater. Rotate knob of combination thermostat/gas valve to "OFF" position.

For Resideo & White Rodgers electronic control, rotate knob counter-clockwise to the "OFF" position.

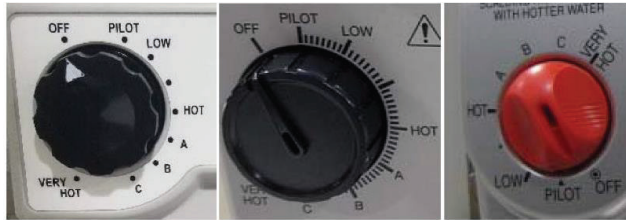

For White Rodgers mechanical control, depress knob slightly and rotate clockwise to the "OFF" position.



- Step 2. Turn off cold water supply to the water heater. Connect a hose to the drain spigot of the water heater and route to an open drain. Open a nearby hot water faucet to vent the heater for draining. Open the drain spigot of the water heater and allow the heater to drain to a point below the outlet connection nipple.
- Step 3. Disconnect the outlet nipple from the plumbing system.
- Step 4. With an appropriate wrench, remove the outlet nipple/anode from the water heater. Use caution to not damage pipe threads.
- Step 5. Visually inspect outlet nipple/anode. Outlet nipple/anode should show signs of depletion; this is normal. If depletion is 1/2 of the original anode diameter (approximately 5/8" diameter), replacement is recommended. If any of the steel core of the anode is exposed, replacement is recommended.
- Step 6. Upon completion of inspection or subsequent replacement, reinstall the outlet nipple/anode into the heater. Ensure pipe dope is used on the nipple's threads. Connect the nipple to the plumbing system, resume water supply, and refill the heater with water.
- Step 7. To resume operation, follow the instructions located on the lighting instruction label or the lighting instructions located in the Installation and Operation Manual.

Parts Diagram

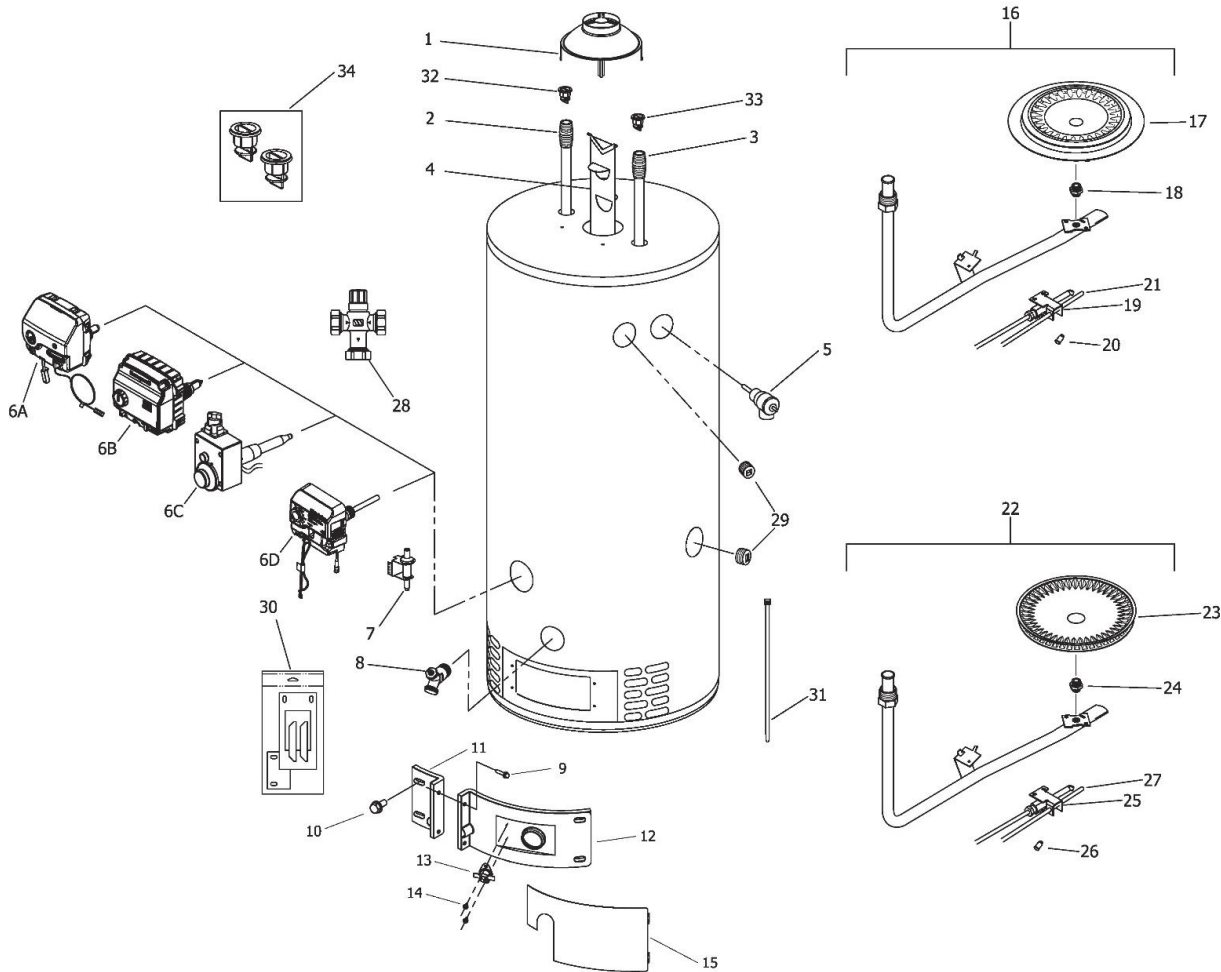

1	Draft Hood	17	Burner Only
2	Hot Water Outlet/Anode	18	Main Burner Orifice
3	Cold Water Inlet Tube	19	Pilot Assembly
4	Flue Baffle	20	Pilot Orifice
5	T&P Relief Valve	21	Thermocouple/Thermopile
6A	Gas Control (ICON System V1)	22	Complete Burner Assembly (LP)
6B	Gas Control (ICON System V2)	23	Burner Only (LP)
6C	Gas Control (White Rodgers Mechanical)	24	Main Burner Orifice (LP)
6D	Gas Control (White Rodgers Electronic)	25	Pilot Assembly (LP)
7	Piezo Igniter (White Rodgers Mechanical)	26	Pilot Orifice(LP)
8	Brass Drain Valve	27	Thermocouple/Thermopile (LP)
9	Screw-#8-18 x 3/4 Hex Washer Head	28	ASSE Approved Mixing Valve (Optional)
10	Screw-#10-12 x 3/4 Hex Washer Head	29	3/4 NPT Tank Plug (H Models)
11	Left Side Inner Door with Gasket	30	Inner Door Gasket Kit
12	Complete Right Side Inner Door	31	Wire Tie
13	Resettable Thermal Switch	32	Heat Trap (Outlet)
14	Screw-#6-20 x 3/8 PHCR	33	Heat Trap (Inlet)
15	Outer Door	34	Heat Trap Kit
16	Complete Burner Assembly (Natural)		



United States

Sales 800-523-2931

Technical Support 800-334-3393

Email techserv@bradfordwhite.com

Warranty 800-531-2111

Email warranty@bradfordwhite.com

Service Parts 800-538-2020

Email parts@bradfordwhite.com

Canada

Sales & Technical Support 866-690-0961 905-203-0600

Fax 905-636-0666

Warranty bwccwarranty@bradfordwhite.com

Technical Support bwccotech@bradfordwhite.com

Service Parts orders@bradfordwhitecanada.com

Orders ca.orders@bradfordwhite.com

For U.S. and Canada field service,
contact your professional installer or
local Bradford White sales representative.

International

General Contact international@bradfordwhite.com